

DSFY/16 actuator with spring return

Application

The DSFY/16 actuator with safety function (spring return) and 0..10 V DC or 0..20 mA control is used to adjust the air dampers in RLT plants.

When the power supply is interrupted, the spring force moves the air dampers back into the fail-safe position.

The drives are equipped with a universal adapter and are mounted directly on the air damper axle.



Content	Page
Important Information Regarding Product Safety	2
Item	3
Technical Data	3
Accessories (not included in delivery)	3
Dimensions	3
Connection	4
Mounting	4
Commissioning	6
Rotational angle limitation setting	6
Control signal setting	7
Inverting the direction of rotation	9
Auxiliary switch setting DSFY/16E	10

Änderungen vorbehalten - Contents subject to change - Sous réserve de modifications - Reservado el derecho a modificación - Wijzigingen voorbehouden - Con riserva di modifiche - Innehåll som skall ändras - Zmeny vyhradené - Změny vyhrázeny - Zmiany zastrzeżone - Возможны изменения - A változtatások jogát fenntartjuk - 保留未经通知而改动的权力

Important Information Regarding Product Safety

Safety Instructions

This data sheet contains information on installing and commissioning the product "DSFY/16". Each person who carries out work on this product must have read and understood this data sheet. If you have any questions that are not resolved by this data sheet, you can obtain further information from the supplier or manufacturer.

If the product is not used in accordance with this data sheet, the protection provided will be impaired.

Applicable regulations must be observed when installing and using the device. Within the EU, these include regulations regarding occupational safety and accident prevention as well as those from the VDE (Association for Electrical, Electronic & Information Technologies). If the device is used in other countries, it is the responsibility of the system installer or operator to comply with local regulations.

Mounting, installation and commissioning work on the devices may only be carried out by qualified technicians. Qualified technicians are persons who are familiar with the described product and who can assess given tasks and recognize possible dangers due to technical training, knowledge and experience as well as knowledge of the appropriate regulations.

Legend



WARNING

Indicates a hazard of medium risk which can result in death or severe bodily injury if it is not avoided.



CAUTION

Indicates a hazard of low risk which can result in minor or medium bodily injury if it is not avoided.



CAUTION

Indicates a hazard of medium risk which can result in material damage or malfunctions if it is not avoided.



NOTE

Indicates additional information that can simplify the work with the product for you.

Notes on Disposal

For disposal, the product is considered waste from electrical and electronic equipment (electronic waste) and must not be disposed of as household waste. Special treatment for specific components may be legally binding or ecologically sensible. The local and currently applicable legislation must be observed.

Product Description**DSFY/16****Item**

DSFY/16	24 V AC actuator with spring return for 16 Nm. Controlled with control signal Y 0..10 V DC or 0..20 mA
DSFY/16/E	Data as above, but with 2 adjustable auxiliary switches

Technical Data

Nominal voltage	24 V AC \pm 20% or 24 V DC \pm 10%
Power consumption	In operation 7.0 W In end position 0.6 W
Control	Control signal Y 0..10 V DC, Ri 200 k Ω or 0..20 mA, Ri 388 Ω
Position indication	Scale on actuator
Position feedback	Position feedback 0..10 V DC, load: R \geq 10 k Ω
Torque	16 Nm for damper surface area up to 3 m ²
Rotational angle	Working range 0..90° Direction of rotation for fail-safe position can be inverted by plugging the adapter sleeve in the opposite way round Adjustable limitation for angle of rotation: 0°..30° or 60°..90°
Run time	Open/closed 90 s via motor for 90° angle of rotation
Safety return	10 s
Auxiliary switches	DSFY/16/E only 2 adjustable auxiliary switches, 230 V AC, 3 (1.5) A, Delivery setting for angle of rotation: 10° and 80°
Degree of protection	IP54 (cable at the bottom)
Ambient temperature	-20°C..+50°C
Ambient humidity	5..95% r.h., non-condensing
Weight	2.9 kg

Accessories (not included in delivery)

ZKGH	Actuating lever with centering pin and 2 ball joints
------	--

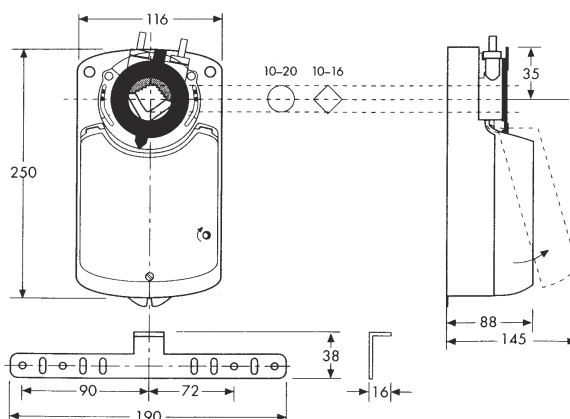
Dimensions

Connection

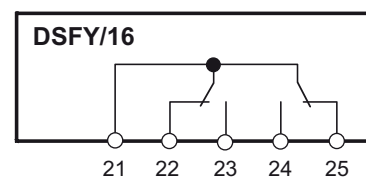
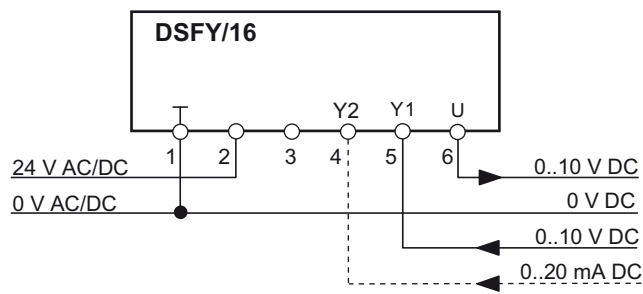

Additional connection for auxiliary switches, 230 V AC, 3 (1.5) A (Contact position at rotational angle of 0°)

Mounting



WARNING

Contact with live components of the building's electrical system can cause death due to electric shock.

Mount or remove only when power is switched off.

Comply with VDE guidelines and local wiring regulations when mounting/removing.



CAUTION

Observe mounting and setting instructions.

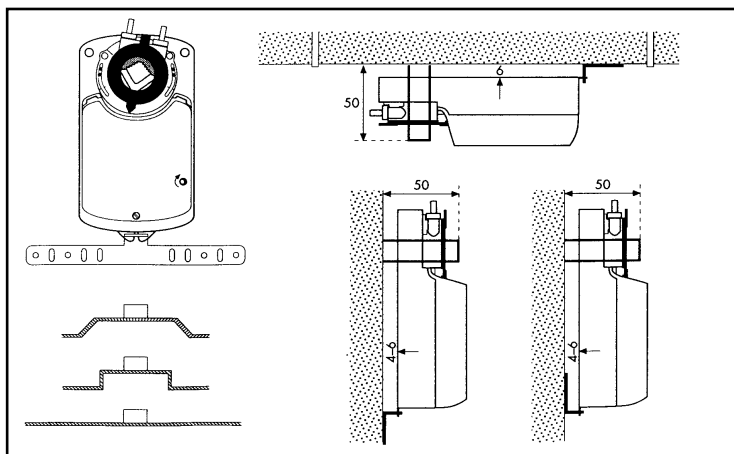

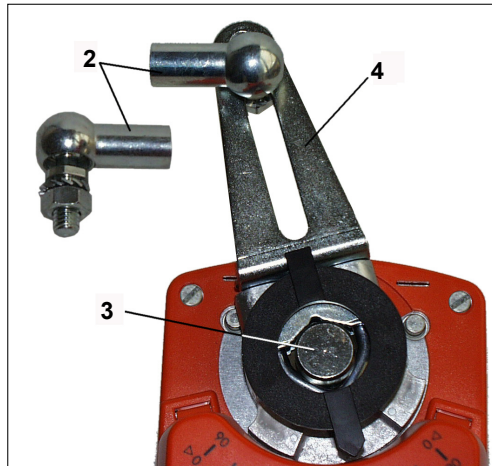
Product Description**DSFY/16**

- (1) Air damper valve
- (2) 2 x KG8
- (3) Centering pin
- (4) Actuating lever

Commissioning

Rotational angle limitation setting



WARNING

Contact with live components of the building's electrical system can cause death due to electric shock.

- Disconnect the actuator from power before removing the cover.

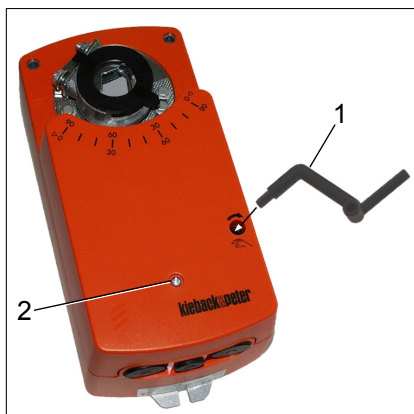

- (1) Crank
- (2) Cover screw

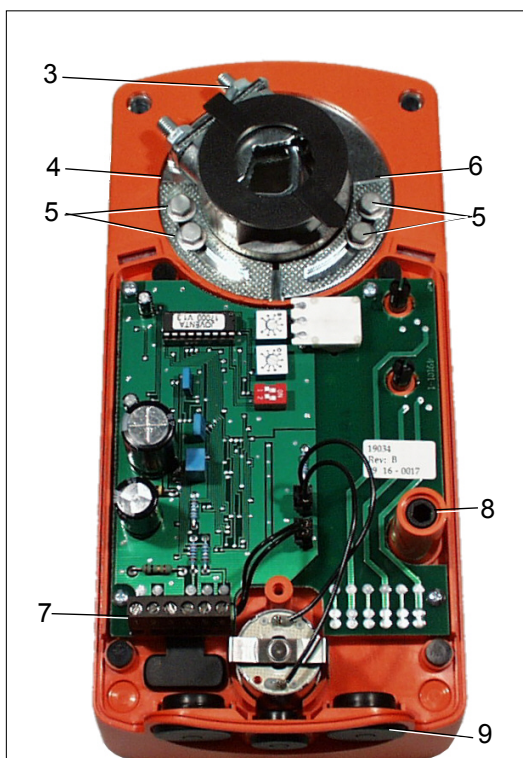

- (3) Terminal clip for securing the air damper valve.
- (4) Left stop for mechanical limitation of rotational angle, adjustable 0°..30°
- (5) Remove the hexagon screw to set the angle.
- (6) Right stop for mechanical limitation of rotational angle, adjustable 0°..30°
- (7) Connection terminal
- (8) Coupling sleeve for crank
- (9) Cable bushing

Actual product not shown

Control signal setting

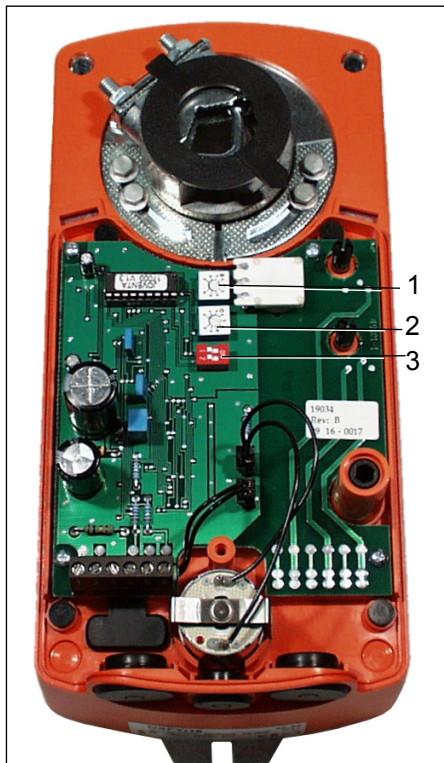

Actual product not shown

- (1) Adjuster **S**
Setting: Control signal Y (slope)
- (2) Adjuster **O**
Setting: Control signal Y (zero point)
- (3) Double switch **A**
Switch 1: Adjusts the Y control signal to the angle of rotation
Switch 2: Inverts the direction of rotation

Adjusters O and S

The Y control signal is preset to 0 to 10 V (Y1) and 0 to 20 mA (Y2) (adjuster O = 0, adjuster S = 10). Using both adjusters O (starting point) and S (working range), the input of the Y control signal can be changed.

For exam- Y1 = 2..10 V Adjuster **O** = 2 Adjuster **S** = 8
ple, for

and

Y2 = 4..20 mA Adjuster **O** = 2 Adjuster **S** = 8

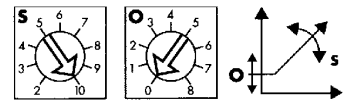

Double switch A

Switch 1 can be used to adjust control signal Y to the mechanical rotational angle of DSY/8..32 (automatic adaptation, on = ON position).

When the switch is set to ON, the actuating drive performs a single initialization run. With the initialization run, both end positions are approached automatically.

ON position: When control signal Y is changed or the rotational angle is automatically limited, control signal Y is adjusted to the available rotational angle.

Delivery setting: Off (for 0 to 10 V, 0 to 20 mA, and 0 to 90° rotational angle).

Switch 2 is used for reversing the rotational direction.

Delivery setting: 0 to 10 V or 0 to 20 mA = right rotational angle, 0° ->90°.

Double switch A (1)



Without adaptation

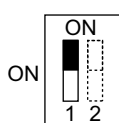

With adaptation

Double switch A (2)

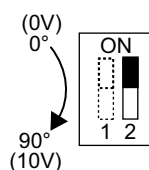

Direction of rotation: clockwise

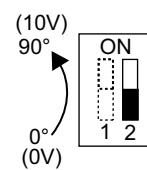

Direction of rotation: counterclockwise

Inverting the direction of rotation

The adapter sleeve needs to be reinserted for the rotational direction to be changed.

For this to happen, the default for the fail-safe position (spring return) is switched from the left end position to the right end position.

Reversing the rotational direction includes changing the fail-safe position:

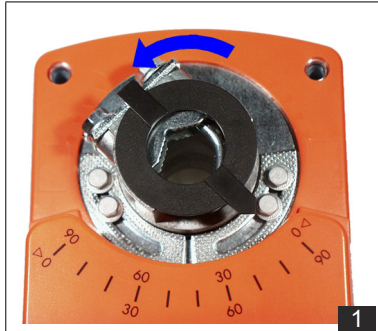

Fail-safe position is on the left.

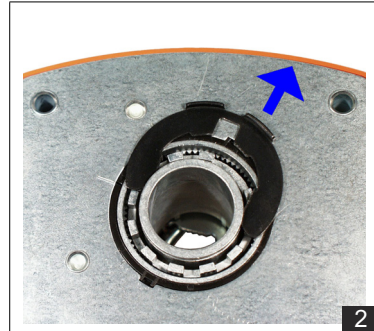

Remove circlip for the adapter (rear of the unit).

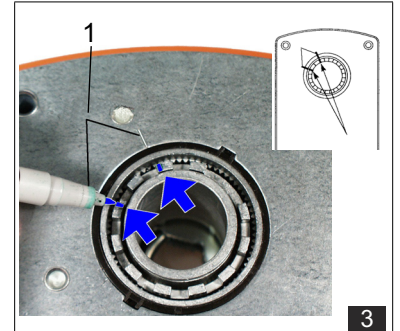

Mark both crown flanks on the position marks (1).

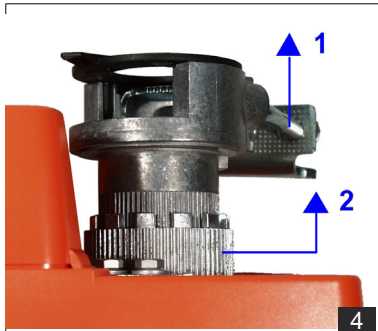

Remove adapter (1) and adapter sleeve (2) from the top.

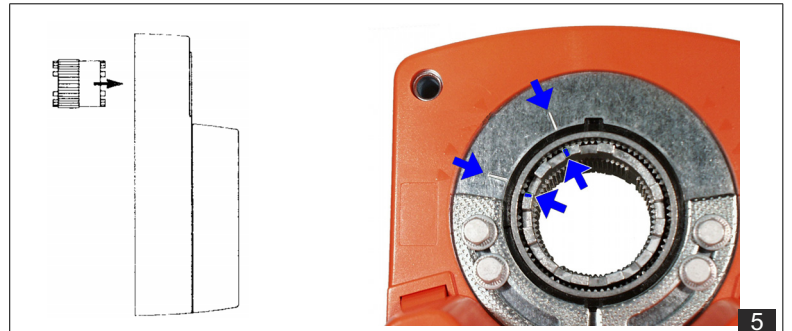

Turn the adapter sleeve and insert from bottom side the unit. The marked crown flanks must match the position marks (1).

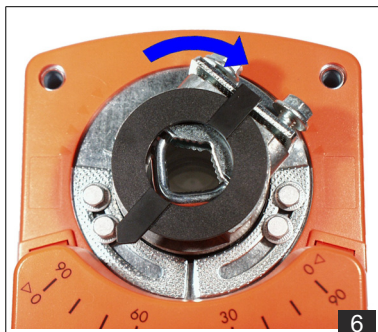

Reinsert the adapter from the top of the unit in the end position on the right.

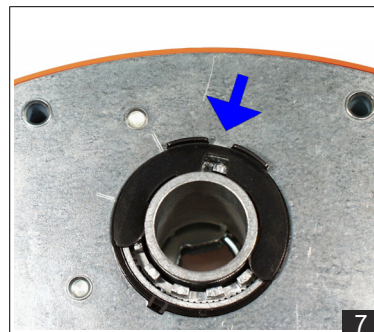

Secure the adapter with the circlip.

Auxiliary switch setting DSFY/16E

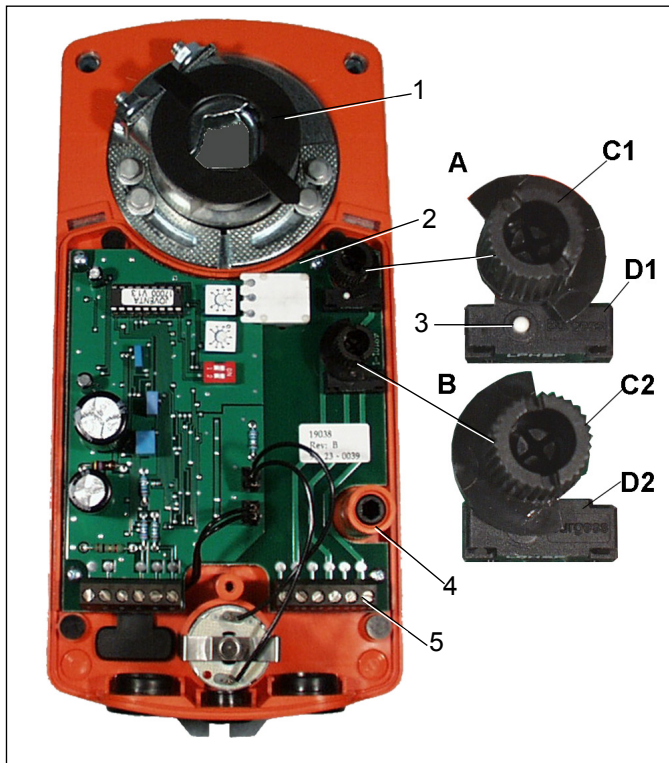

- (1) Adapter with position indicator
- (2) Markings for position indicator in 10° increments on housing
- (3) Pressure pin for manual adjustment
- (4) Coupling sleeve for manual adjustment
- (5) Connection terminal for auxiliary switches

Actual product not shown

Factory setting

Auxiliary switch A: Switches when angle of rotation > 10°

Auxiliary switch B: Switches when angle of rotation > 80°

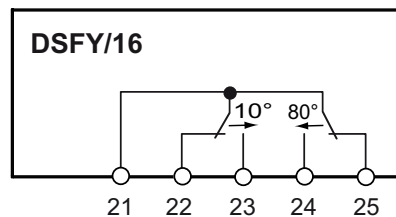

Setting example

- Switch off mains power supply and remove the cover.
- Auxiliary switch A - Set to 30° rotational angle:
 - Move sliding switch for manual adjustment and set adapter to 30° rotational angle.
 - Turn ratchet wheel D1 until microswitch E1 switches.
- Auxiliary switch B - Set to 70° rotational angle:
 - Move sliding switch for manual adjustment and set adapter to 70° rotational angle.
 - Turn ratchet wheel D2, until microswitch E2 switches.
- Replace the cover, switch on mains power supply, and perform operational check.