

**technolon® Room Module DDC110-L1, DDC110-L2, DDC110-L3 and DDC110-L4**

Single room control or room display and service module for single-room control in the LON network. With display of the room temperature and manual adjustment of the room setpoint.

The DDC110-L2 technolon® Room Module has an additional user button for switching 3 ventilator speeds and temperature types

The DDC110-L3 technolon® Room Module additionally has another user button for switching day /night or standby operation and temperature type

The DDC110-L4 technolon® Room Module, like DDC110-L3, additionally also has a user button for switching 3 ventilator speeds



With an I/O component (accessory), message inputs and servo devices for heating and cooling as well as 3-level fan control can be directly connected to a technolon® Room Module .

<b>Contents</b>	Notes on the device description	Page	2
	Safety Instructions	Page	2
	Qualified specialists	Page	2
	Application	Page	3
	Types	Page	3
	Technical data	Page	3
	Operating	Page	4
	Assembly	Page	10
	Installation	Page	12
	Initial operation	Page	12

Contents subject to change

Issue date: 05/27/2005

**Kieback & Peter GmbH & Co KG**

Tempelhofer Weg 50, D-12347 Berlin  
 Telephone +49 (0) 30 / 600 95-0  
 Telefax +49 (0) 30 / 600 95 164  
 E-Mail: [info@kieback-peter.de](mailto:info@kieback-peter.de)  
<http://www.kieback-peter.de>

**kieback&peter**  
 Technology for building automation

### Notes on the device description

The description contains references for the deployment and assembly of the technolon<sup>®</sup> Room Module. In case of questions which cannot be clarified with this device description, please refer to the supplier or manufacturer for further information.

The indicated installation instructions/regulations are valid in the Federal Republic of Germany. When using the I/O components in other countries, the builder or operator of the plant is responsible for compliance with the respective national regulations.

The operating staff is to be instructed in accordance with the description of the technical data sheet.

### Safety Instructions

The currently valid worker's occupational health regulations and regulations for the prevention of industrial accidents must be observed when assembling and using the devices.

Any work concerning the installation or initial operation of the control devices shall be exclusively carried out by qualified specialists, see section "Qualified specialists".

Every person using the devices shall have read and understood the descriptions in the technical data sheet.

Meaning of the symbols in the technical data sheet:



Danger

Warning of dangerous electrical voltage



Warning

General warning, strictly observe this notice



Note

Further notice to observe

**Danger**

means mortal danger, severe bodily injuries or serious material damage in case of non-observance.

**Warning**

means danger of bodily injuries or material damage in case of non-observance.

**Note**

indicates information which is particularly emphasized.

### Qualified specialists

Qualified specialists for the purposes set out in this technical data sheet are persons who are familiar with the described devices and possess a qualification for their respective occupation.

These are for instance:

- Authorization to connect the devices according to the VDE rules and local Electricity Board regulations, as well as the authorization to switch the devices on and off taking the in-house regulations into account.
- Knowledge of the regulations for the prevention of industrial accidents.
- Knowledge of the utilization of the devices within the plant system.
- etc.

**Device Description**

**DDC110-L1 .. DDC110-L4 technolon® Room Module**

**Application**

The technolon® Room Modules DDC110-L1, DDC110-L2, DDC110-L3 and DDC110-L4 are employed in the single-room control of the LON network as Single Room Control or as room displays and service modules .

An I/O component UP can be connected at the Room Module as an accessory. The I/O component provides the direct connection of a presence detector and a window contact or dew-point detector, the direct connection of the heating and cooling circuit as well as the activation of 3-level ventilators. The I/O component is installed in a double flush-mounted box.



DDC110-L1



DDC110-L2



DDC110-L3



DDC110-L4























**Types**

- DDC110-L1      technolon® Room Module with display of the room temperature and manual adjustment of the room setpoint.
- DDC110-L2      technolon® Room Module with display of the room temperature and manual adjustment of the room setpoint as well as switching of three ventilator speeds.
- DDC110-L3      technolon® Room Module with display of the room temperature and manual adjustment of the room setpoint as well as switchover to day /night or standby operation
- DDC110-L4      technolon® Raummodul with display of the room temperature and manual adjustment of the room setpoint as well as switchover to day /night or standby operation

**Accessories      I/O componenets**

- UP1              2 Digital inputs for the connection of the window contact/dew-point detector and presence detector  
                     2 Thyristor switching outputs 24 V AC, 1 A                      (1 x heating, 1 x cooling)
- UP2              like UP1, however additionally  
                     3 Relay outputs 250 V AC, 6 A (3-level fan control)
- UP3              2 Digital inputs for the connection of the window contact/dew-point detector and presence detector  
                     2 analog outputs 0..10 V DC, 10 mA                      (1 x heating, 1 x cooling)
- UP4              like UP1, however additionally  
                     3 Relay outputs 250 V AC, 6 A (3-level fan control)

**Technical data – Room Module DDC110-L1 to DDC110-L4**

Mains	24 V AC/DC ± 10 %, 10 mA (without I/O component UP)	
Bus connection	- LON FTT10 Application: According to LONMARK standard: LONMARK profile #8060 for single room control or LONMARK profile #8090 for room display and service module - Bus for I/O component UP on plug contact	
Measured variable	Room temperature in residential and office space	
Measuring system	integrated digital room sensor	
Measuring range	0..45°C	
Connection	Terminal connection, max, 2.5 mm <sup>2</sup>	
Display	LCD display - Rough measured value 0..45.0°C, resolution 0.1 K - Room setpoint 0..45.0°C, resolution 0.1 K - Display icon for operating modes	
Control buttons	DDC110-L1	 Key, control setting of the room temperature
	DDC110-L2	 Key, switchover to temperature type for setting the room setpoint
		 Key, switchover to ventilator modules for manual switching of the ventilator speeds
		 Key, setting the room setpoint or manual switching of the ventilator speeds backlighting of the keys   depending on the configuration: Steady burning light, on for 5 sec after keystroke, or backlighting off
	DDC110-L3	 Key, switchover to day operation
		 Key, switchover to night or standby operation
		 Key, switchover to temperature type for setting the room setpoint Backlighting of the keys    depending on the configuration: Steady burning light, on for 5 sec after keystroke or backlighting off
	DDC110-L4	 Key, switchover to day operation
		 Key, switchover to night or standby operation
		 Key, switchover to temperature type for setting the room setpoint
		 Key, switchover to ventilator modules for manual switching of the ventilator speeds
		 Key, switchover to ventilator modules for manual switching of the ventilator speeds  Key, setting the room setpoint or manual switching of the ventilator speeds Backlighting of the keys     depending on the configuration: Steady burning light, on for 5 sec after keystroke or backlighting off
Housing	Hood, color RAL9010 (pure white) Special colors upon request	
Ambient conditions	Temperature	0..45°C, Humidity not condensing
Degree of enclosure protection	IP30	
Dimensions	Width x height x depth: 82.5 x 82.5 x 30 mm	
Assembly	Wall mounted/assembly in flush-mounted box	
Weight	110 g	

**Operation DDC110-L1**

Display depending on the configuration:

Room temperature (actual value) with function symbol 

or

Room setpoint with function symbol 

Other function symbols can be displayed depending on the configuration:

 Day operation

 Night operation

 Standby operation

} Automatic switchover by  
Central Program or presence  
detector



► **Room setpoint selection**





The room setpoint for day, night or standby operation is automatically determined by the program.

Depending on the configuration release, the room setpoint can be raised or lowered by  $\pm 3$  K or  $\pm 5$  K by manual adjustment.

The manual adjustment acts as setpoint correction for all operating modes alike:

Example: If the current room setpoint day is raised by 2 K,  
then the room setpoint night and the room setpoint standby are raised by 2 K .

Key  $-|+$  Press once : The Room Module switches to temperature type control setting.

Function symbols   or  or  are displayed,  
Simultaneously, the decimal place of the current control setting blinks .

Now the room setpoint can be increased or lowered with the key  $-|+$  in steps of 0.1 K .

Without pressing a key, the Room Module switches back to the standard after 5 sec display .  
The new room setpoint is stored.



**Operation DDC110-L2**

Display depending on the configuration:

Room temperature (actual value) with function symbol   
or

Room setpoint with function symbol 

Other function symbols can be displayed depending on the configuration:

-  Day operation
  -  Night operation
  -  Standby operation
- } Automatic switchover by Central Program or presence detector







► **Room setpoint selection**

The room setpoint for day, night or standby operation is automatically determined by the program. Depending on the configuration release, the room setpoint can be raised or lowered by ± 3 K or ± 5 K by manual adjustment.

The manual adjustment acts as setpoint correction for all operating modes alike:

Example: If the current room setpoint day is raised by 2 K, then the room setpoint night and the room setpoint standby are raised by 2 K .

Key  Press once : The Room Module switches to temperature type control setting.

Function symbols   or  or  are displayed, Simultaneously, the decimal place of the current control setting blinks .

Now the room setpoint can be increased or lowered with the key  in steps of 0.1 K .

With the key , it is immediately possible to switch back to the standard display. Without pressing a key, the Room Module switches back to the standard after 5 sec display . The new room setpoint is stored.





► **Switching ventilator speeds on and off**

The ventilator speeds are automatically switched on and off by the program .

If required, the ventilator speeds can be switched by manual control.

Key  and the Room Module switches to ventilator mode for manual control.

Function symbol  is displayed, Simultaneously, the current ventilator setting blinks 0, 1, 2, 3 or auto.

0	Ventilator off,	No function symbol
1	Ventilator level 1 on	Function symbol 
2	Ventilator level 2 on	Function symbol 
3	Ventilator level 3 on	Function symbol 
Auto	Automatic operation:	Function symbol  lights up in seconds beat

The new ventilator level is set with the key  .

With the key , it is immediately possible to switch back to the standard display. Without pressing a key, the Room Module switches back to the standard after 5 sec display . The new room setpoint is stored.

### Operation DDC110-L3

Display depending on the configuration:

Room temperature (actual value) with function symbol   
or

Room setpoint with function symbol 

Other function symbols can be displayed depending on the configuration:

 Day operation

 Night operation

 Standby operation

} Automatic switchover by  
Central Program or presence  
detector



#### ► Room setpoint selection

The room setpoint for day, night or standby operation is automatically determined by the program.

Depending on the configuration release, the room setpoint can be raised or lowered by  $\pm 3$  K or  $\pm 5$  K by manual adjustment.

The manual adjustment acts as setpoint correction for all operating modes alike:

Example: If the current room setpoint day is raised by 2 K,  
then the room setpoint night and the room setpoint standby are raised by 2 K .

Key  $-|+$  Press once : The Room Module switches to temperature type control setting.

Function symbols   $\updownarrow$  or  $\updownarrow$  or  $\updownarrow$  are displayed,  
Simultaneously, the decimal place of the current control setting blinks .

Now the room setpoint can be increased or lowered with the key  $-|+$  in steps of 0.1 K .

Without pressing a key, the Room Module switches back to the standard after 5 sec display . The new room setpoint is stored.

#### ► Switch on day or standby operation

The night or standby operation is automatically switched on or off by the Central Program.



The day operation is switched on by the presence detector or manually with the key  .

##### Switch on day operation

The day operation can only be switched on manually in the operation mode night or standby .

For the manual switching of night to day operation, the day operation  is switched on only for a time period determined by the program .

After expiration of this time, the Room Module switches back to night operation.

Switch on day operation Press key  , function symbol  is displayed.  
When switching over from night to day operation, the time period for switched on day operation is displayed for 5 sec.

##### Standby operation

The standby operation can be switched on by a presence detector or manually only in the daytime operation mode, e.g. upon vacating the room.

Standby operation Press key  , function symbol is displayed.

The key  switches off the standby operation again .



**Operation DDC110-L4**

Display depending on the configuration:

Room temperature (actual value) with function symbol   
or

Room setpoint with function symbol 

Other function symbols can be displayed depending on the configuration:

-  Day operation
  -  Night operation
  -  Standby operation
- } Automatic switchover by Central Program or presence detector







► **Room setpoint selection**

The room setpoint for day, night or standby operation is automatically determined by the program. Depending on the configuration release, the room setpoint can be raised or lowered by  $\pm 3$  K or  $\pm 5$  K by manual adjustment.

The manual adjustment acts as setpoint correction for all operating modes alike:

Example: If the current room setpoint day is raised by 2 K, then the room setpoint night and the room setpoint standby are raised by 2 K .

Key  Press once : The Room Module switches to temperature type control setting.

Function symbols   or  or  are displayed, Simultaneously, the decimal place of the current control setting blinks .

Now the room setpoint can be increased or lowered with the key  in steps of 0.1 K .

With the key , it is immediately possible to switch back to the standard display. Without pressing a key, the Room Module switches back to the standard after 5 sec display . The new room setpoint is stored.

► **Switch on day or standby operation**

The night or standby operation is automatically switched on or off by the Central Program.



The day operation is switched on by the presence detector or manually with the key  .

**Switch on day operation**

The day operation can only be switched on manually in the operation mode night or standby .

For the manual switching of night  to day operation, the day operation is switched on only for a time period determined by the program .

After expiration of this time, the Room Module switches back to night operation.

Switch on day operation Press key , function symbol  is displayed. When switching over from night to day operation, the time period for switched on day operation is displayed for 5 sec.

Standby operation

The standby operation can be switched on by a presence detector or manually only in the daytime operation mode, e.g. upon vacating the room.

Standby operation Press key , function symbol is displayed.

The key  switches off the standby operation again .



► **Switching ventilator speeds on and off**





The ventilator speeds are automatically switched on and off by the program .  
If required, the ventilator speeds can be switched by manual control.

Key 

and the Room Module switches to ventilator mode for manual control.

Function symbol  is displayed,

Simultaneously, the current ventilator setting blinks 0, 1, 2, 3 or auto.

0	Ventilator off,	No function symbol
1	Ventilator level 1 on	Function symbol 
2	Ventilator level 2 on	Function symbol 
3	Ventilator level 3 on	Function symbol 
Auto	Automatic operation:	Function symbol  lights up in seconds beat

The new ventilator level is set with the key  $-|+$  .

With the key  , it is immediately possible to switch back to the standard display.  
Without pressing a key, the Room Module switches back to the standard after 5 sec display . The new room setpoint is stored.

**Assembly**



The assembly may only be carried out by qualified personnel on voltage-free switched connecting leads.

Warning The Room Module can be mounted in the wall or in a flush-mounted box.

For rapid and correct measurement of the room temperature, the Room Module is to be assembled in such a way that the airflow of the room is included.

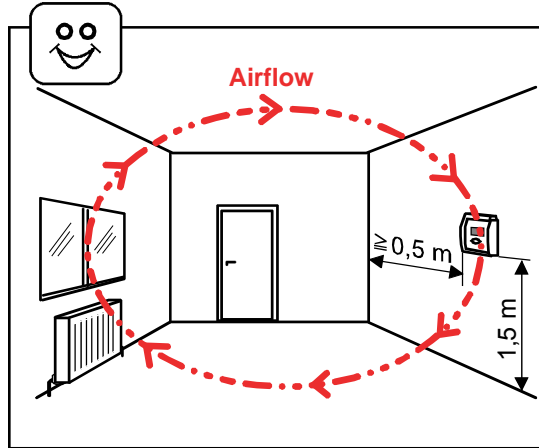

correct

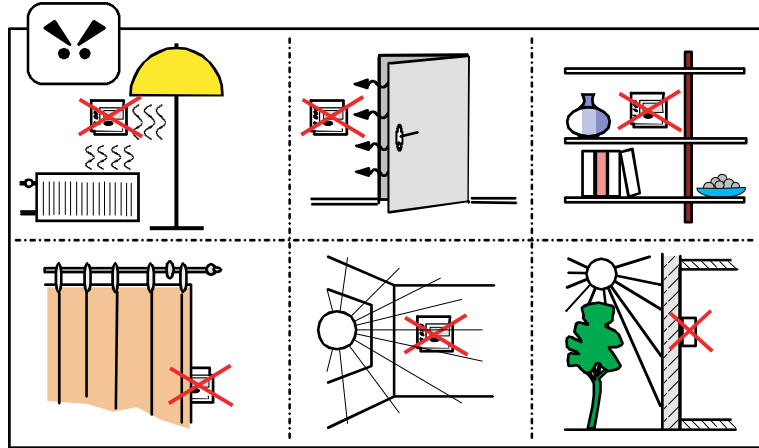

false

**Assembly**

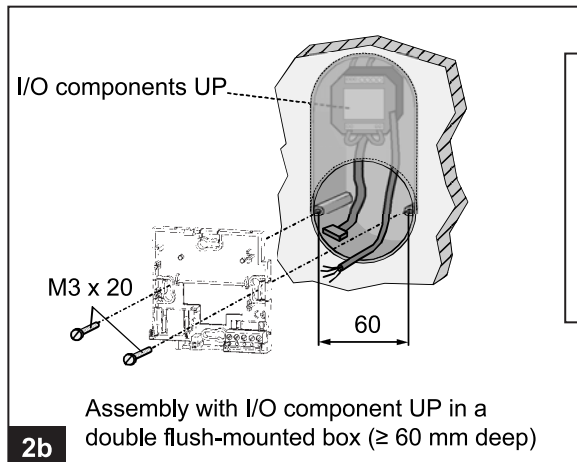
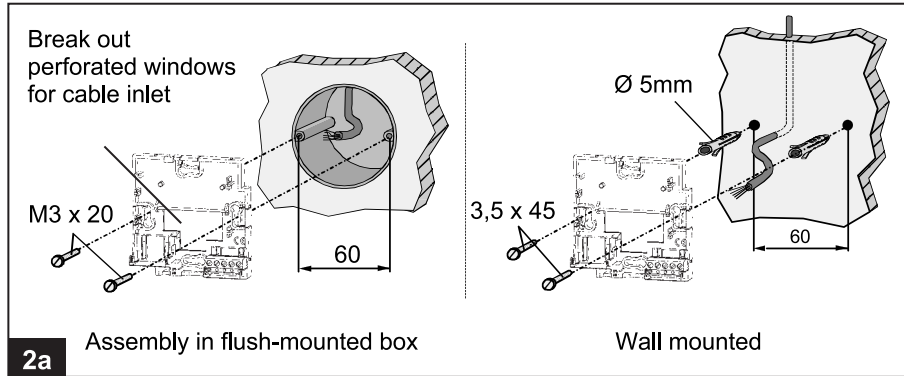
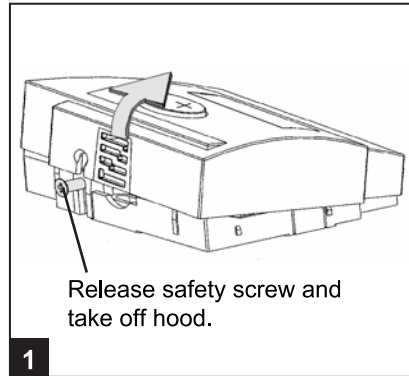

**Danger**  
Supply voltage 230 V for assembly with I/O component possible!  
Note section on installation without fail!

Device Description

DDC110-L1 .. DDC110-L4 technolon® Room Module

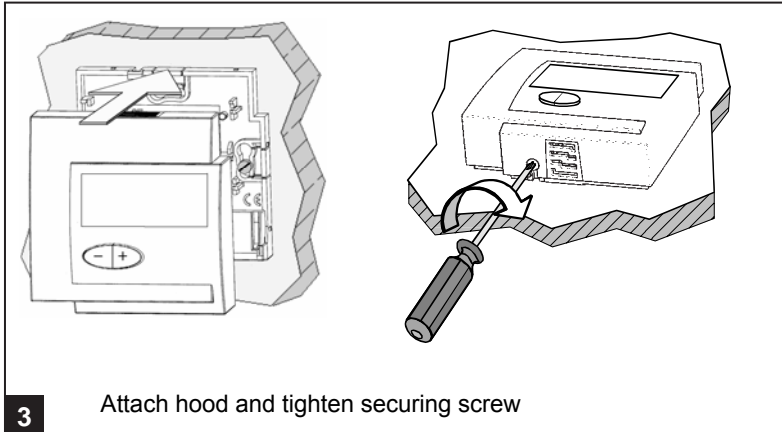

3 Attach hood and tighten securing screw

For surface-mounted or flush-mounted wiring, the hood and base have labelled housing parts that can be broken out depending on the cable leads.



Furthermore, pluggable hood inserts are a part of the delivery which can be exchanged for the standard inserts :

Note

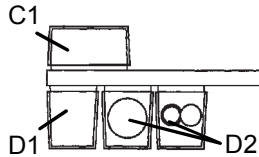

C1/D1 Inserts without air vents for greater wall influence.

D2 Inserts for cable inlet from below. The device protection type IP30 is only guaranteed when the air gap at the cable inlet is  $\leq 2.5$  millimeters.



In the building phase, the carton box serves as protective cover. Please tear off the box top and depress side straps to the inside .

## Installation

 **The electrical installation and the Room Module connection may only be carried out by qualified personnel.**

Warning This must be done in accordance with the VDE regulations and local specifications.

### Connection

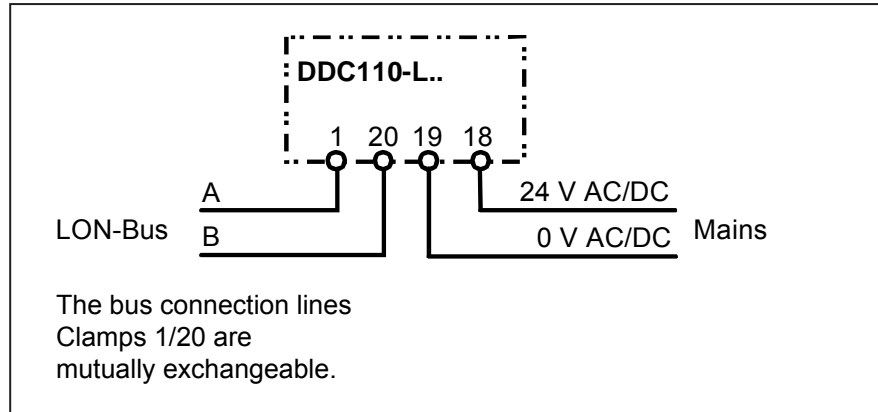

 **Warning: Supply voltage 230 V for use of I/O components UP2 or UP4!**  
**Note without fail the technical device manual in the Technical Data Sheet 1.10-51.110-91 !**

Danger

The I/O component UP with inputs and outputs can be connected at the Room Module .  
Room Module and I/O component form a device unit.

The I/O component is employed in a double flush-mounted box with a depth of at least 60 millimeters,  
the Room Module is mounted on the flush-mounted box.

The connection between the Room Module and the I/O component UP is carried out on the 5-line  
bus line of the I/O component which is connected with a socket plug on the Room Module .

## Initial operation

 **Warning! Warning: Supply voltage 230 V for use of I/O components UP2 or UP4!**  
**Initial startup by switching on the supply voltage may only take place after the configuration setting and connection testing of the Room Module by the startup technician/engineer.**

Danger

- Before mains network has been switched on, check
  - the electric wiring acc. to VDE (Association of German electrotechnicians) regulations and the local regulations,
  - te correct mounting location for recording the room temperature,
  - the competent assembly as well as
  - the permissible ambient conditions according to the technical data.
- The Room Module is configured as a single room tool control or as display and service module with the parameter settings on a network management tool (e.g. LonMaker) with the service PC.
- After the network is switched on, check
  - the total function of the Room Module (if necessary. including I/O component UP)
  - with the plant components of the room control loop.